



Micro Focus Enterprise Analyzer 3.5 Update 1

A large, decorative graphic consisting of multiple overlapping, wavy blue lines that create a sense of motion and depth, positioned in the lower half of the page.

Getting Started

Micro Focus
The Lawn
22-30 Old Bath Road
Newbury, Berkshire RG14 1QN
UK
<http://www.microfocus.com>

Copyright © Micro Focus 2009-2014. All rights reserved.

MICRO FOCUS, the Micro Focus logo and Enterprise Analyzer are trademarks or registered trademarks of Micro Focus IP Development Limited or its subsidiaries or affiliated companies in the United States, United Kingdom and other countries.

All other marks are the property of their respective owners.

2014-12-11

Contents

| | |
|--|-----------|
| Introducing Enterprise Analyzer | 5 |
| Enterprise Analyzer Products | 5 |
| Enterprise Analyzer | 5 |
| Enterprise View | 6 |
| Business Rule Manager | 6 |
| How Enterprise Analyzer Models Applications | 6 |
| Understanding Application-Level Information | 7 |
| Understanding Object-Level Information | 7 |
| Workspaces and Projects | 7 |
| Single-User versus Multiuser Environments | 8 |
| Multiuser Environment Basics | 8 |
| Deployment Scenario | 8 |
| EA Privileges | 9 |
| Dropping Indexes | 10 |
| Computing Statistics | 11 |
| Enterprise Analyzer Basics | 12 |
| Creating a Workspace in Oracle or DB2 | 12 |
| Creating a Workspace in SQL Server | 13 |
| Creating a Workspace Using the Workspace Build Wizard | 14 |
| Designating Users for Security Policies | 15 |
| Designating Users in a Simple Security Policy | 15 |
| Designating Users in a Three-Group Security Policy | 15 |
| Refreshing the Workspace Path | 16 |
| Connecting to a Workspace in Oracle or DB/2 | 16 |
| Connecting to a Workspace in SQL Server | 17 |
| Opening a Workspace | 18 |
| Registering Source Files | 18 |
| Host Environment Source Compatibility | 19 |
| Queue Processor | 22 |
| Check Workspace Queue | 22 |
| Manage Queue | 23 |
| Verifying Source Files | 23 |
| How Verification Results Are Indicated | 24 |
| Quick Inventory | 24 |
| Using the Enterprise Analyzer Main Window | 25 |
| Menus | 25 |
| Toolbars | 25 |
| Project Filtering | 25 |
| Using the Repository Browser Pane | 26 |
| Using the Editor and Viewer | 31 |
| Using the Object Information Pane | 32 |
| Viewing Object Properties | 33 |
| Viewing Inventory Reports | 33 |
| Viewing Key Object Relationships with Query Repository | 34 |
| Using the Activity Log | 34 |
| Creating a To Do List | 34 |
| Viewing a To Do List | 35 |
| Using Tool Windows | 35 |
| Resizing Panes | 35 |
| Moving Panes | 35 |
| Setting Options | 36 |

| | |
|--|----|
| Managing Option Sets | 36 |
| Setting General Options | 38 |
| Setting Environment User Preferences | 39 |
| Setting Archivers User Preferences | 39 |
| Setting Export Options | 39 |
| Adding a Selectable Item | 39 |
| Working with Reports and Diagrams | 40 |
| Using the Guide for a Tool | 40 |
| Purge Activity Log | 40 |

Introducing Enterprise Analyzer

Micro Focus Enterprise Analyzer (EA) offers centralized storage and analysis of enterprise application portfolios:

- Language-specific parsers generate a common repository of application objects, in the industrial-strength DBMS of your choice.
- Sophisticated analysis tools give you convenient interactive access to the repository, in a multiuser environment that facilitates exchange of information and insight across the enterprise.

The result is a single easy-to-use interface in which you analyze assets written in modern languages like Java and C# alongside assets written in legacy languages like COBOL and PL/I. And in which you perform the analysis with industry-leading tools that offer deep, detailed, and comprehensive insight into complex modern distributed applications.

Enterprise Analyzer Products

Enterprise Analyzer is a suite of PC-based software products for storing, analyzing, and re-architecting enterprise applications. The products are deployed in an integrated environment with access to a common repository of program objects. Language-specific parsers generate repository models that serve as the basis for a rich set of diagrams, reports, and other documentation. Each product is separately licensed.

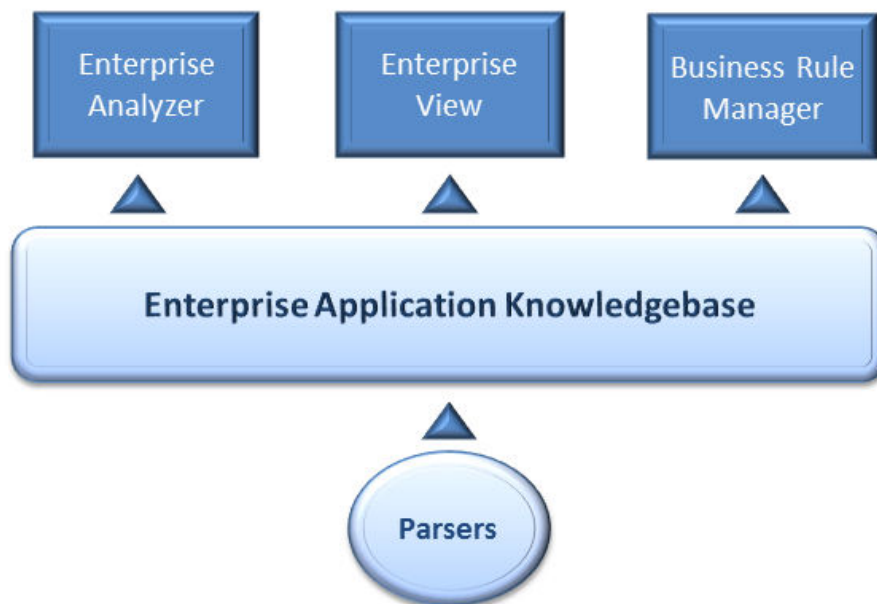

Enterprise Analyzer

Enterprise Analyzer is a robust set of non-invasive interactive tools that work with source code, system files, DDL, screen maps, and more. Use it for analyzing and documenting legacy systems at both the application and program levels.

Use Enterprise Analyzer at the application level to:

- Create diagrams of applications.
- Perform change analysis across applications.
- Estimate application complexity and effort.

Use Enterprise Analyzer at the program level to:

- Perform program analysis in stages.
- Perform impact analysis on a program.
- Model and search the repository.

Enterprise View

Enterprise View (EV) is a Web server-based tool that offers IT executives "at-a-glance" application portfolio management (APM). EV charts and tables provide powerful graphical insight into APM trends and current status, on dashboards that make it easy to drill down from the "big picture" captured at the highest level to the lower-level details that support it.

With EV you can:

- Create, distribute, and gather responses to surveys about your organization's application portfolio and business processes.
- Mine application complexity metrics from the EA repository.
- Track survey and repository metrics in EV's rich variety of interactive charts, displayed on dashboards structured to show the rollup of data from lower to higher levels.

For users who need to drill down even deeper into an application portfolio, EV lets you search, filter, and analyze EA repository data. You can:

- Query the repository for information about application objects.
- Search, browse, and edit business rules and triggers.

Business Rule Manager

Business rule mining encapsulates your application's business logic, making the application easier to understand, document, and test. It lowers the risk and cost of maintenance and enhancement, and ensures that all business logic is implemented in modernization efforts.

A *business rule* is a named container for program code that performs a discrete task in a business process. It identifies and documents the code segment that performs this task. A business rule named Calculate Date Difference, for example, might consist of this segment:

```
COMPUTE WS-DATE-VARIANCE = WS-C-CARD-DATE-CCYYMM - WS-TODAYS-DATE-CCYYMM.
```

Business Rule Manager (BRM) offers a powerful set of tools for autodetecting, and autodocumenting, business rules. You can batch edit rule attributes; create custom attributes suited to your particular needs; match input/output data elements with the business names you've assigned to them in your project glossary; and much more.

How Enterprise Analyzer Models Applications

Enterprise Analyzer is a model-based technology that generates information about legacy applications at two levels:

- Application-level information describes the relationships between the *objects* that comprise an application: its programs, copybooks, JCLs, BMS files, and so forth.
- Object-level information describes the relationships between the abstract syntactical *constructs* that comprise an object: its sections, paragraphs, statements, conditions, variables, and so forth.

At both levels, the models are conceived as *Entity Relationship Diagrams (ERDs)*. Each object or construct the parser generates is modeled as an entity in one of the diagrams. The models are represented in tree form to users.

Understanding Application-Level Information

The *object model* for an application defines the relationships between the objects that comprise the application. These can be physical objects, like program source files or JCLs, or logical objects that identify abstract program elements: entry points, data stores, screens, jobs, and the like.

The *relationships* between objects describe the ways in which they interact. In the figure, the source file GSS.CBL *defines* the GSS program. The program, in turn, *reads* the data file GSS.FCSTSEC.

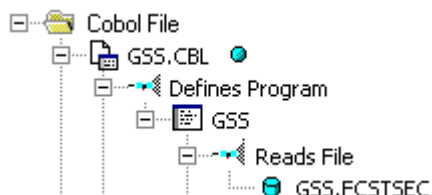

Understanding Object-Level Information

The *construct model* for an object defines its syntax. It shows in abstract form how the syntactical constructs that comprise the object (its sections, paragraphs, statements, conditions, variables, and so forth) are related. A variable, for example, can be related in the construct model to its declaration, a dataport (if it is used in an I/O statement), or a condition (if the condition uses an expression of which the variable forms a part).

The figure shows a portion of the construct model for the GSS program. The model shows that the program executes a PERFORM statement if the value of the variable EIBRESP satisfies the condition EIBRESP NOT EQUAL DFHRESP(NORMAL).

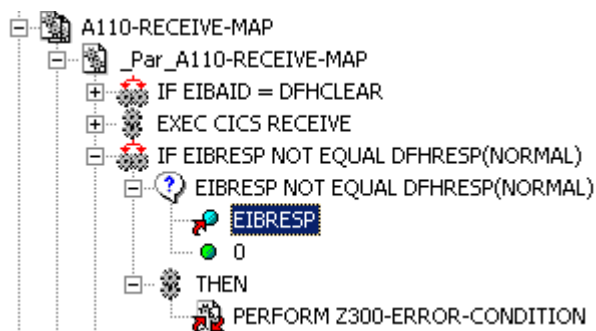

If you are interested in investigating other uses of EIBRESP in the program, you can navigate to the declaration of the variable in the construct model, and from the declaration to each instance of the variable's use in the program.

Workspaces and Projects

Enterprise Analyzer uses the familiar notions of workspace and project to help users organize application source files conveniently. A *workspace* is a named container for one or more applications. Every workspace has a corresponding database *repository* of model objects.

You can divide a workspace up into *projects* that represent different applications or different portions of an application. You might have a project for the batch portion of an application and another project for the online portion, for example. You can also use a project to collect items for discrete tasks: all the source files affected by a change request, for example.

When you set up a workspace in Enterprise Analyzer, the system creates a default project with the same name as the workspace. You can create new projects and move or copy entities between projects as needed.

A workspace can contain objects coded in different programming languages. You can create multiple workspaces on the same machine.

Single-User versus Multiuser Environments

Enterprise Analyzer can be deployed in a single-user or multiuser environment:

- In a single-user environment, the workspace repository resides on the local machine, and can be accessed by the owner of the machine only. Limited facilities exist for sharing work with other users.
- In a multiuser environment, the workspace repository resides on a database server, and can be accessed by any user with appropriate database privileges.

Most installations deploy Enterprise Analyzer in a multiuser environment. Single-user mode typically is reserved for special needs.

The guidelines that follow for multiuser environments apply equally to single-user environments. For installation instructions, see the installation guide for your product.

Multiuser Environment Basics

A multiuser Enterprise Analyzer environment gives members of a development team common access to a workspace repository on a database server. Workspace setup is the responsibility of a master user, leaving team members free to focus on their tasks. Common access makes it easy to share insights across the team, and ensures that team members view the same source and work with the same option settings.

Deployment Scenario

The figure below shows a standard deployment scenario for the Enterprise Analyzer multiuser environment. The role each machine performs and its key relationships are described below. Keep in mind that the view is logical. Machine roles can be combined or separated as required.

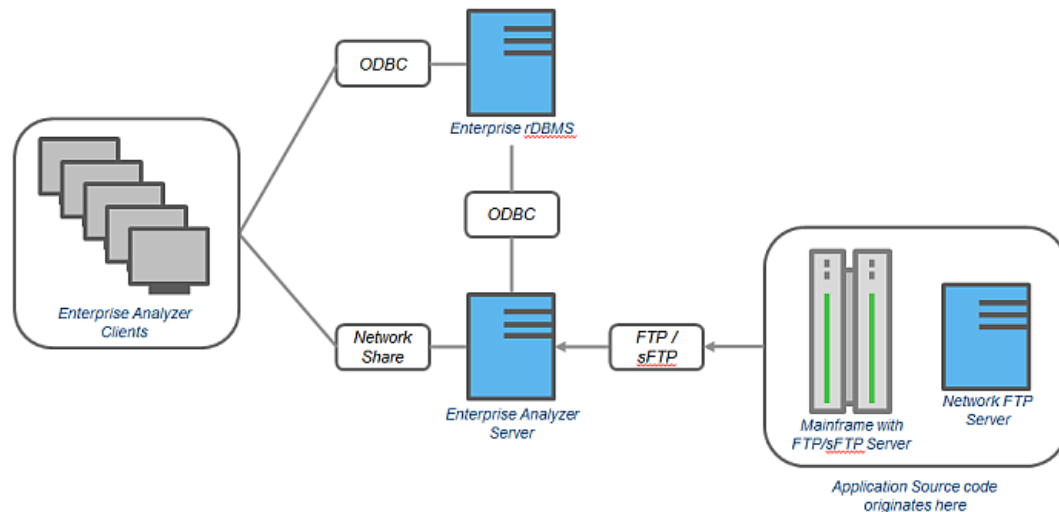

Mainframe and Network Server

The mainframe hosts the application to be modeled in Enterprise Analyzer. Application source files are downloaded from the mainframe (and, if necessary, a network server) to the Enterprise Analyzer server via FTP or SFTP.

Enterprise Analyzer Server

The Enterprise Analyzer server hosts workspaces, workspace support files (including the copies of application source files the product creates at workspace loading), and workspace output. This server leverages multiple processes to enhance parsing performance in online or batch mode.

Parsed data is sent via ODBC to the database server. Some analysis output is stored on the EA server as well.

Database Server

The database server hosts the database for one or more multiuser repositories. This server provides centralized, network-accessible storage for parsed data and analysis output.

The EA server, Enterprise View Web Server, and EA clients access the database server via ODBC. For guidance on database setup, see the installation guide for your product.

Enterprise Analyzer Client

EA clients host the *link files* that let team members connect to workspaces on the EA server. These clients access repository data stored in the database server via ODBC.

Enterprise View Web Server

The Enterprise View web server hosts services used by intranet and internet clients to display charts and to access web-based view of repositories.

Enterprise View Web Client

Enterprise View web clients provide multiuser access to charts and workspace repository data via the Enterprise View web server.

EA Privileges

Privileges in a multiuser environment work on two assumptions:

- Team members typically do not need to modify files until they have completed analysis and are ready to test a proposed change.
- The team lead is best situated to make the change and reverify the modified file.

For these reasons, the EA multiuser environment has no need for file checkout and locking of the kind seen in conventional multiuser environments.

Understanding Master Users

The user who creates a workspace on a Enterprise Analyzer server machine is referred to as its *owner*. Initially, only the owner has *master user* privileges for the workspace.

The master user can delete the workspace, upgrade the workspace configuration, register and verify source files, modify source, autoresolve decisions, perform restricted Clipper searches, create, assign, and delete tags, and so forth. The master user can also designate new master users for the workspace.

Ordinary users *connect* to the workspace from Enterprise Analyzer client machines. These users can perform any task not restricted to the master user: analyze programs, mine business rules, extract components, and so forth.

If you do not have master user privileges for a workspace, you will not see menu choices for privileged methods. The same team member can be a master user for one workspace and an ordinary user for another.

Understanding Workspace Security Policies

When you create a workspace, you can choose from two workspace security policies:

- The *Simple Security Policy* recognizes two classes of users, master users and ordinary users.
- The *Three-Group Security Policy* recognizes a third class of users, *subject matter experts (SMEs)*, with special privileges to create, assign, and delete tags.

In each policy, the master user can create new master users.

Using the Optional File Server

When you create a workspace, you can restrict Windows access to workspace source files to master users, while using the optional File Server to make the source files available in EA only to ordinary users. As long as you set up workspace folder privileges correctly, ordinary users can view and analyze sources in the product, but cannot access them otherwise. For file server installation instructions, see the installation guide for your product.

Public and Private Visibility

In a multiuser environment, the user who creates a workspace resource (a project or a Clipper list, for example) is referred to as its *owner*. Only the owner can *share* the resource with other users.

A shared, or *public*, resource is visible to other members of your team. A *private* resource is not. If a public resource is *protected*, team members can view but not edit or delete the resource. A Clipper list, for example, is always protected.

You can turn sharing on and off in the tool you use to create the resource. Look for a symbol like this one for a shared project  to indicate that the resource is shared.

Protecting Projects

By default, projects are *unprotected*: any user to whom the project is visible can add source files, include or exclude objects.



Note: Only a master user or the owner of a shared unprotected project can delete it.

The project owner or master user can designate a project as *protected*, in which case *no* user can delete or modify the project, including the project owner or master user: the project is read-only, until the project owner or master user turns protection off.

Turn on protection by selecting the project in the Repository pane and choosing **Project > Toggle Protection**. Choose **Project > Toggle Protection** again to turn it off. Look for a symbol like this one  to indicate that a project is protected.

Dropping Indexes

If you are a master user with responsibility for verifying source files in a multiuser environment, you will almost always want to *drop database indexes* to improve verification performance. You will be prompted to drop indexes when you verify the application, or you can drop indexes at a time of your own choosing by selecting **Prepare > Drop Repository Indexes**.

When you drop indexes, you are prompted to restore the indexes when you analyze the files. If you want to restore indexes at a time of your own choosing, choose **Prepare > Restore Repository Indexes**.

Computing Statistics

You typically need to *gather statistics* for your system before the optimizer for your RDBMS can determine the most efficient way to execute SQL statements. If you are a master user with responsibility for verifying source files in a multiuser environment, you will almost always want to gather system statistics after verification to improve performance of the Enterprise Analyzer analysis tools.



Note: Check with your DBA before gathering system statistics. In Oracle, you must have GATHER_SYSTEM_STATISTICS privileges to execute this method. Make sure to restore indexes before gathering system statistics.

To gather system statistics, choose **Prepare > Compute Database Statistics**. You can view the generated statistics in your RDBMS.

Enterprise Analyzer Basics

This section describes elementary EA tasks: how to create a workspace and project, register and verify source files, use the browser and other EA windows, set options, and export system diagrams and reports.

Creating a Workspace in Oracle or DB2

You create a workspace on the Enterprise Analyzer server machine. Other users *connect* to the workspace from Enterprise Analyzer client machines. The workspace repository resides on a database server, and can be accessed by any user with database privileges to the repository.



Note: Do not modify the name of the workspace after you create it. Doing so will cause unpredictable results.

Before creating a workspace, you must configure an ODBC data source name (DSN) for the database that holds the workspace repository, as described in the installation guide for your product. You will need the following DSN configuration information to create the workspace:

- The data source name.
- The database schema name your DBA created for the repository.
- The database user name and password that give access to the schema.
- If required by your DBMS, the name of the tablespace your DBA created for the repository. If the DBA also created a tablespace for database indexes, you will need the name of that tablespace as well.

The folder in which you plan to create workspaces must be shared with team members. It's usually more convenient to share the folder before you create workspaces, but you can do it afterward if necessary, then refresh the workspace path.

It is the responsibility of the workspace creator to designate users for security policies. Perform this task as soon as you have finished creating the workspace, then periodically edit the list of users as required.

1. Choose **Start > Programs > Micro Focus > Enterprise Analyzer > Enterprise Analyzer Administration**. The Administration window opens.
2. Choose **Administer > New Workspace**. The Create new workspace dialog opens.
3. In the Create new workspace dialog, double-click the **New Workspace** icon for the RDBMS in use at your site or select it and click **OK**. The New workspace dialog opens.
4. In the New workspace dialog, choose the location for the workspace in the **Save in** drop-down. In the **File name** field, enter the name of the workspace. Choose a name that describes the legacy application as closely as possible. Click **Save**. The Define Connection Parameters dialog opens.
5. In the Define Connection Parameters dialog, click the Connection tab. On the Connection tab, enter:
 - The ODBC data source name you defined at ODBC data source configuration. If you have not defined a data source name, or want to use a different data source name, click **ODBC Manager** to open the data source name configuration dialog, then follow the instructions for ODBC data source configuration in the installation guide for your product.
 - The database schema name your DBA created for the workspace repository.
 - The database user name and password that give access to the schema.
 - If required by your DBMS, the name of the tablespace your DBA created for the repository. If your DBA also created a tablespace for database indexes, enter the name of that tablespace in the **Tablespace for Indexes** field. These fields are displayed only for DBMSs that require a tablespace name to be specified.
6. Click the Security tab. In the Policies list box, select:

- **Simple Security Policy** if you want to enforce a workspace security policy that recognizes two classes of users, master users and ordinary users.
 - **Three-Group Security Policy** if you want to enforce a workspace security policy that recognizes a third class of users, *subject matter experts (SMEs)*, with special privileges to create, assign, and delete tags.
7. In the Files access group box on the Security tab, select:
- **Direct sources access via Windows share** if your site does not restrict Windows access to workspace source files to the master user.
 - **Secure sources access via EA file server** if your site restricts Windows access to workspace source files to the master user, while using the optional file server to make the source files available in the product to ordinary users. Make sure the values for the server name and port number fields are correct.

 **Note:** For File Server installation and setup instructions, see the installation guide for your product.

8. Click **OK**.

 **Note:** If you created the workspace in a non-shared folder, you are warned to that effect and prompted to share the folder. After you share the folder, make sure to refresh the workspace path.

You are notified that the workspace was created successfully. Enterprise Analyzer creates a workspace file (.rwp) and a folder with the same name in the specified location. The workspace folder contains support files and subfolders for EA output. A project with the same name as the workspace is displayed in the Repository Browser.

Creating a Workspace in SQL Server

You create a workspace on the Enterprise Analyzer server machine. Other users *connect* to the workspace from Enterprise Analyzer client machines. The workspace repository resides on a database server, and can be accessed by any user with database privileges to the repository.

 **Note:** Do not modify the name of the workspace after you create it. Doing so will cause unpredictable results.

The folder in which you plan to create workspaces must be shared with team members. It's usually more convenient to share the folder before you create workspaces, but you can do it afterward if necessary, then refresh the workspace path.

It is the responsibility of the workspace creator to designate users for security policies. Perform this task as soon as you have finished creating the workspace, then periodically edit the list of users as required.

You can use Microsoft SQL Server Express to create a workspace on your local machine. Enterprise Analyzer creates a database for the workspace "on the fly," with no intervention on your part. If you do use SQL Server Express, keep in mind that the Windows user who creates the workspace must have been configured with appropriate permissions in SQL Server Express. The user who installed SQL Server Express will always have the appropriate permissions. See the SQL Server Express documentation for configuration instructions.

 **Note:** For Windows XP installations using the Italian locale, you must set the Time format in the Control Panel Regional Language Options to "HH:mm:ss" before attempting to verify an EA workspace with a SQL Server repository. Click **Settings > Control Panel > Regional and Language Options > Customize > Time** and choose "HH:mm:ss" from the **Time format** drop-down.

1. Choose **Start > Programs > Micro Focus > Enterprise Analyzer > Enterprise Analyzer Administration**. The Administration window opens.
2. Choose **Administer > New Workspace**. The Create new workspace dialog opens.
3. In the Create new workspace dialog, double-click the **New Workspace** icon for the RDBMS in use at your site or select it and click **OK**. The New workspace dialog opens.

4. In the New workspace dialog, choose the location for the workspace in the **Save in** drop-down. In the **File name** field, enter the name of the workspace. Choose a name that describes the legacy application as closely as possible. Click **Save**. The Define Connection Parameters dialog opens.

 **Note:** This dialog does not open for Microsoft SQL Server Express. The product starts creating the workspace immediately.

5. In the Define Connection Parameters dialog, click the Connection tab. Define the connection:

- In the **Server** field, enter the server name. The server name must be of the form `<machine>\<SQL server>`.
- In the **Database Name** field, enter the database name your DBA created for the workspace repository.
- In the **Integrated Security** drop-down, select the integrated security provider interface in use at your site. Choose:
 - **Windows Authentication** if users connect to the workspace repository through a Windows user account.
 - **Server Authentication** if users connect to the workspace repository through an SQL Server login account.
- If you chose **Server Authentication**, enter the database login name in the **User Name** field and the login password in the **Password** field.

 **Note:** The database user name and login name are typically, but not always, the same. If you have trouble connecting, it may be because you are specifying the database user name rather than the login name.

6. Click the Security tab. In the Policies list box, select:

- **Simple Security Policy** if you want to enforce a workspace security policy that recognizes two classes of users, master users and ordinary users.
- **Three-Group Security Policy** if you want to enforce a workspace security policy that recognizes a third class of users, *subject matter experts (SMEs)*, with special privileges to create, assign, and delete tags.

7. In the Files access group box on the Security tab, select:

- **Direct sources access via Windows share** if your site does not restrict Windows access to workspace source files to the master user.
- **Secure sources access via EA file server** if your site restricts Windows access to workspace source files to the master user, while using the optional file server to make the source files available in the product to ordinary users. Make sure the values for the server name and port number fields are correct.

 **Note:** For File Server installation and setup instructions, see the installation guide for your product.

8. Click **OK**.

 **Note:** If you created the workspace in a non-shared folder, you are warned to that effect and prompted to share the folder. After you share the folder, make sure to refresh the workspace path.

You are notified that the workspace was created successfully. Enterprise Analyzer creates a workspace file (.rwp) and a folder with the same name in the specified location. The workspace folder contains support files and subfolders for EA output. A project with the same name as the workspace is displayed in the Repository Browser.

Creating a Workspace Using the Workspace Build Wizard

The Workspace Build Wizard helps you create an Enterprise Analyzer workspace. Stepping through it, you add your source files, associate files with source types and analyze the files so that they are ready to be used in Enterprise Analyzer.



Note: To use the wizard, you must have SQL Server Express installed on the machine.

Designating Users for Security Policies

When you create a workspace, you choose from two workspace security policies:

- The *Simple Security Policy* recognizes two classes of users, master users and ordinary users.
- The *Three-Group Security Policy* recognizes a third class of users, *subject matter experts (SMEs)*, with special privileges to create, assign, and delete tags.

In each policy, the master user can create new master users.

Designating Users in a Simple Security Policy

A Simple Security Policy recognizes two classes of users, master users and ordinary users. Initially, only the workspace creator has master user privileges. The master user can designate new master users as described in this section.

1. Choose **Start > Programs > Micro Focus > Enterprise Analyzer > Enterprise Analyzer Administration**. The Administration window opens.
2. Choose **Administer > Edit Users**. The Edit Users dialog opens.
3. In the Edit Users dialog, select the workspace (.rwp file) for which you want to edit users and click **Open**. The Security dialog opens.
4. The Security dialog displays a list of users who have connected to the workspace in the Known Users list box and a list of master users in the Master Users list box. Select a known user and click the **>** button to move the known user into the list of master users. Select a master user and click the **<** button to move the master user into the list of known users.



Note: Click **Refresh** at any time to update the lists.

5. To create a new master user, click **(New User...)** in the Master User list box. A dialog opens prompting you to enter the name of the new master user. Enter the name and click **OK**.
6. When you are satisfied with your entries, click **Close**.

Designating Users in a Three-Group Security Policy

A Three-Group Security Policy recognizes a third class of workspace users in addition to master users and ordinary users: *subject matter experts (SMEs)*, with special privileges to create, assign, and delete tags. Initially, only the workspace creator has master user privileges. The master user can designate SMEs and new master users as described in this section.

1. Choose **Start > Programs > Micro Focus > Enterprise Analyzer > Enterprise Analyzer Administration**. The Administration window opens.
2. Choose **Administer > Edit Users**. The Edit Users dialog opens.
3. In the Edit Users dialog, select the workspace (.rwp file) for which you want to edit users and click **Open**. The Security dialog opens.
4. The Subject Matter Experts and Master Users tabs of the Security dialog display a list of users who have connected to the workspace in the Known Users list box and a list of subject matter experts and master users, respectively, in the opposite list box. Select a known user and click the **>** button to move the known user into the list of subject matter experts or master users. Select a master user and click the **<** button to move the subject matter expert or master user into the list of known users.

 **Note:** Click **Refresh** at any time to update the lists.

5. To create a new subject matter expert or master user, click **(New User...)** in the Subject Matter Experts or Master Users list box. A dialog opens prompting you to enter the name of the new subject matter expert or master user. Enter the name and click **OK**.
6. When you are satisfied with your entries, click **Close**.

Refreshing the Workspace Path

The folder in which you plan to create workspaces must be shared with team members. It's usually more convenient to share the folder before you create workspaces, but you can do it afterward if necessary, then refresh the workspace path as described below. You can also use the refresh path feature when you move a workspace.

 **Note:** For instructions on how to share a workspace folder, see the installation guide for your product.

1. Click **Start > Programs > Micro Focus > Enterprise Analyzer > Enterprise Analyzer Administration**. The Administration window opens.
2. Click **Administer > Refresh Workspace Path**. The Select workspace dialog opens.
3. Select the workspace (.rwp file) you want to refresh and click **Open**. The Workspace directory network path dialog opens. The Workspace directory network path dialog opens.
4. In the Workspace directory network path dialog, enter the path of the workspace in the text field. The path must be of the form `\machine_name\share_name\workspace_folder_name`, where `machine_name` is the name of the machine where the shared folder resides, `share_name` is the value of the Share name field on the Sharing tab of the Properties dialog for the shared folder, and `workspace_folder_name` is the name of the folder for the workspace.

 **Note:** The shared folder is the folder that contains the .rwp file for the workspace, not the workspace folder. The workspace folder (containing support files and subfolders for EA output) resides on the same level as the .rwp file.

5. Click **OK**.

Connecting to a Workspace in Oracle or DB/2

Once a workspace has been created on the Enterprise Analyzer server machine, other users can *connect* to the workspace from EA clients. When you connect to a workspace, you create a *link file* with connection information that points to the workspace. Because the connection information is already stored in the file, you don't have to enter it again when you reopen the workspace connection. Like a workspace file, a link file has a .rwp extension.

Before connecting to a workspace, you must configure an ODBC data source name (DSN) for the database that holds the workspace repository you want to link to, as described in the installation guide for your product. You will need the following DSN configuration information to connect to the workspace:

- The data source name.
 - The database schema name your DBA created for the repository you want to link to.
 - The database user name and password that give access to the schema.
1. Choose **Start > Programs > Micro Focus > Enterprise Analyzer**. The Open Existing workspace dialog opens above the Enterprise Analyzer main window. Click **Cancel** to dismiss the dialog.
 2. Choose **File > Build New Connection**. The Define Server Workspace Connection dialog opens.
 3. In the Define Server Workspace Connection dialog, select the ODBC driver for the RDBMS in use at your site in the **Database Provider** drop-down. In the Required Parameters group box, enter:

- The ODBC data source name you defined at ODBC data source configuration. If you have not defined a data source name, or want to use a different data source name, click **ODBC Manager** to open the data source name configuration dialog, then follow the instructions for ODBC data source configuration in the installation guide for your product.
- The database schema name your DBA created for the workspace repository.
- The database user name and password that give access to the schema.



Note: The **Tablespace** and **Tablespace for Indexes** fields are for future use.

4. When you are satisfied with your entries in the Define Server Workspace Connection dialog, click the **Browse** button for the **Save Link As (.rwp)** field. The Save Server Workspace Connectivity dialog opens.
5. In the Save Server Workspace Connectivity dialog, choose the location for the workspace link in the **Save in** drop-down. In the **File name** field, enter the name of the link. Click **Save**. The linked workspace opens in the Enterprise Analyzer main window. EA creates a link file (.rwp) in the specified location.

Connecting to a Workspace in SQL Server

Once a workspace has been created on the Enterprise Analyzer server machine, other users can *connect* to the workspace from EA clients. When you connect to a workspace, you create a *link file* with connection information that points to the workspace. Because the connection information is already stored in the file, you don't have to enter it again when you reopen the workspace connection. Like a workspace file, a link file has a .rwp extension.

1. Choose **Start > Programs > Micro Focus > Enterprise Analyzer**. The Open Existing workspace dialog opens above the Enterprise Analyzer main window. Click **Cancel** to dismiss the dialog.
2. Choose **File > Build New Connection**. The Define Server Workspace Connection dialog opens.
3. In the Define Server Workspace Connection dialog, click the Connection tab. Define the connection:
 - In the **Server** field, enter the server name. The server name must be of the form *<machine>\<SQL server>*.
 - In the **Database Name** field, enter the database name your DBA created for the workspace repository.
 - In the **Integrated Security** drop-down, select the integrated security provider interface in use at your site. Choose:
 - **Windows Authentication** if you connect to the workspace repository through a Windows user account.
 - **Server Authentication** if you connect to the workspace repository through an SQL Server login account.
 - If you chose **Server Authentication**, enter the database login name in the **User Name** field and the login password in the **Password** field.



Note: The database user name and login name are typically, but not always, the same. If you have trouble connecting, it may be because you are specifying the database user name rather than the login name.

4. When you are satisfied with your entries in the Define Server Workspace Connection dialog, click the **Browse** button for the **Save Link As (.rwp)** field. The Save Server Workspace Connectivity dialog opens.
5. In the Save Server Workspace Connectivity dialog, choose the location for the workspace link in the **Save in** drop-down. In the **File name** field, enter the name of the link. Click **Save**. The linked workspace opens in the Enterprise Analyzer main window. EA creates a link file (.rwp) in the specified location.

Opening a Workspace

The procedure for opening a workspace is the same whether you created the workspace or simply connected to it. You can also open a workspace by double-clicking it in the file system. You don't have to close a workspace before opening another workspace.

1. Choose **Start > Programs > Micro Focus > Enterprise Analyzer**. The Open Existing workspace dialog opens above the Enterprise Analyzer main window.



Note: If Enterprise Analyzer is already open, choose **File > Open Workspace**.

2. Click the tab you want to work in:

- In the Existing tab, choose the drive and folder for the workspace you want to open. A list of workspaces in the selected folder is displayed in the righthand pane. Double-click the workspace you want to open, or select it and click **OK**.
- In the Recent tab, double-click the recently opened workspace you want to open, or select it and click **OK**.



Note: If you created the workspace in a previous release of Enterprise Analyzer, the system prompts you to upgrade the workspace to the new release. Click **Yes**.

The workspace is displayed in the Enterprise Analyzer window. If a workspace was already open in the window, the selected workspace replaces it.

Registering Source Files

Before you can analyze application source files in Enterprise Analyzer, you need to load, or *register*, the source files in a workspace.



Note: In a multiuser environment, only a master user can register source files.

The EA creates copies of the registered files on the server machine (or locally in a single-user environment) in the Sources folder for the workspace. These are the files you view and edit in the EA tools. You can restore a file to its original state, update it to its current state, or export it as necessary.

Source files must have recognized DOS file extensions before they can be registered. You can view and add to the recognized extensions in the Workspace Registration options window. Files without extensions are checked for content, and if the content is recognized, the files are registered with appropriate extensions appended.

EA assumes that input source files are ASCII files in DOS format. Occasionally, files may be converted incorrectly from other formats to DOS-based ASCII with an extra special character (like "M") at the end of each line. While Enterprise Analyzer accepts these files as input, some EA tools may not work correctly with them. Make sure all source files are in valid ASCII format.

You can register source files in compressed formats (ZIP or RAR), as well as uncompressed formats. Enterprise Analyzer automatically unpacks the compressed file and registers its contents.





Note: EA extracts compressed source files using the command line syntax for archiver versions most widely in use. If you use newer archiver versions, specify the command line syntax in the Archivers tab of the User Preferences window.

Workspace Registration options determine registration behavior. The default values for these options are preset based on your configuration and should be appropriate for most installations.

1. In the Repository Browser, create a project for the source files you want to register, or use the default project. To create a project, choose **Project > New Project**. The Create Project dialog opens. Enter the name of the new project and click **OK**. The new project is displayed in the Repository Browser.
2. Select the project in the Repository Browser, then copy-and-paste (**Ctrl+C** and **Ctrl+V**) or drag-and-drop (if UAC is disabled) the file or folder for the source files you want to register onto the Repository Browser. You are notified that you have registered the files successfully and are prompted to verify the files. Click **Close**. The Repository Browser displays the contents of the new workspace either by folder, or by type, depending on the tab you have selected - **Folders** or **Types**. The former displays the contents of the repository in the same folder structure as the one they have on the host environment, the latter displays them by object type.

 **Note:** When updating or adding new sources through the EA main window, the files or folders being registered will be included into the selected folder in the Folders view. Registration into the Types view will copy the selected files and folders directly to the root Sources folder, i.e. they will not be copied into any other existing folders. If you are registering files or folders in Folders view, make sure you've selected in the tree the exact folder in which you want them to be registered. If you haven't selected any folder, they will be copied into the root Sources folder.

 **Important:** Before registering your source files, you must create a folder structure that replicates the original. This helps to avoid errors when you work with homonyms. Micro Focus recommends putting each application in a separate folder, putting system files that are common for more than one application in one directory. After you do that, register your sources by selecting the folders and including them in the project as described in step 2.

 **Note:** In the notification dialog, select **Never ask again** if you do not want to be prompted to verify files. On the Environment tab of the User Preferences window, select **Ask user about verification** if you want to be prompted again.

Host Environment Source Compatibility

When you register your source files, it is essential that they are organized in the same folder structure as the one on your host environment. This allows EA to create the correct relationships when connecting programs with their copybooks, JCLs with the proper version of the procedures that are used, etc. Run-time connections are also established based on this structure. Furthermore, this structure allows for having several members with the same name, i.e. homonyms.

The sources to be loaded into EA should be in folders named after the PDS libraries on the Mainframe and those folders should be the ones loaded.

Example

There is an enterprise organization with 3 data centers: Data Center 1 with one Mainframe, Data Center 2 with two Mainframes, and Data Center 3 with one Mainframe.

The following image shows the folders in a Windows environment:

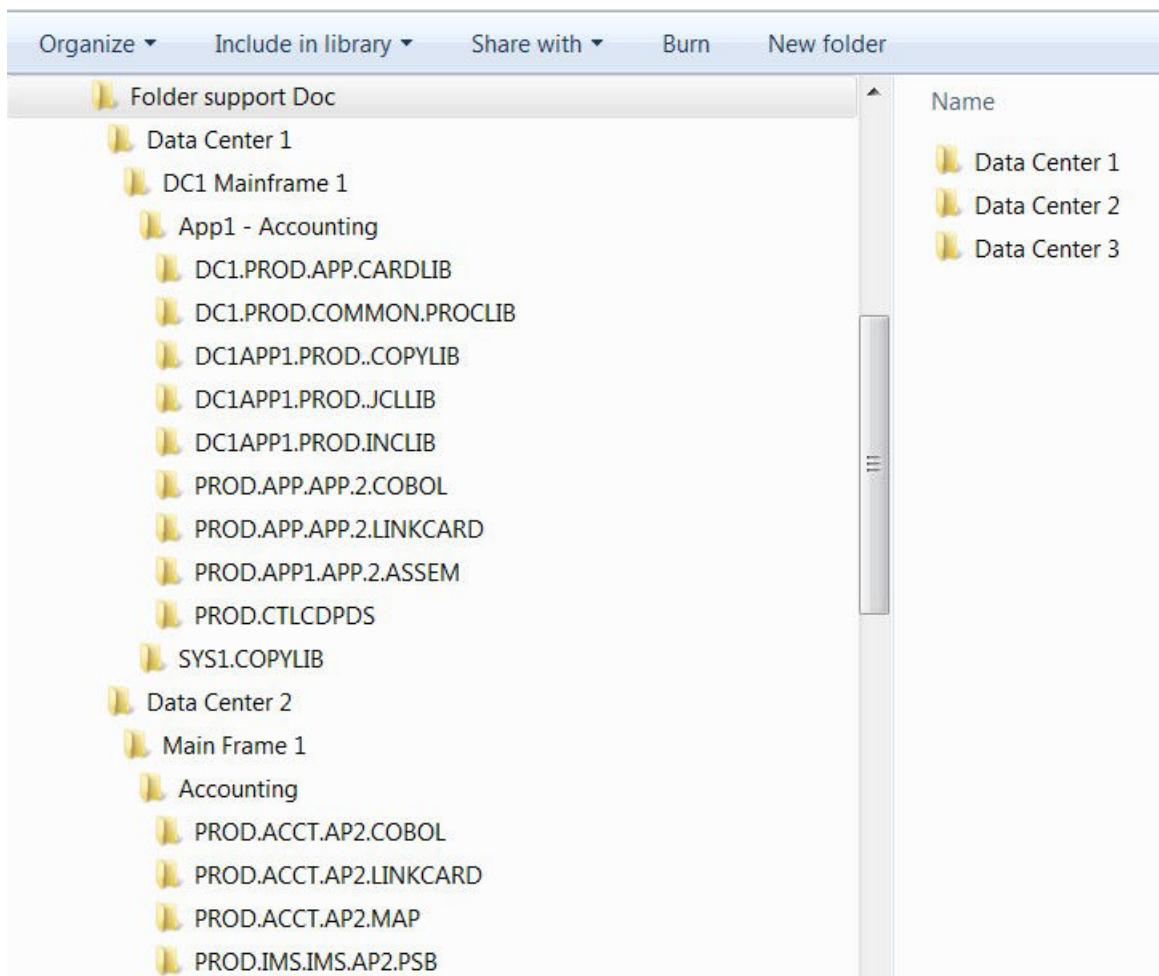

And this is what the three data center folders look like after they have been copied to the workspace:

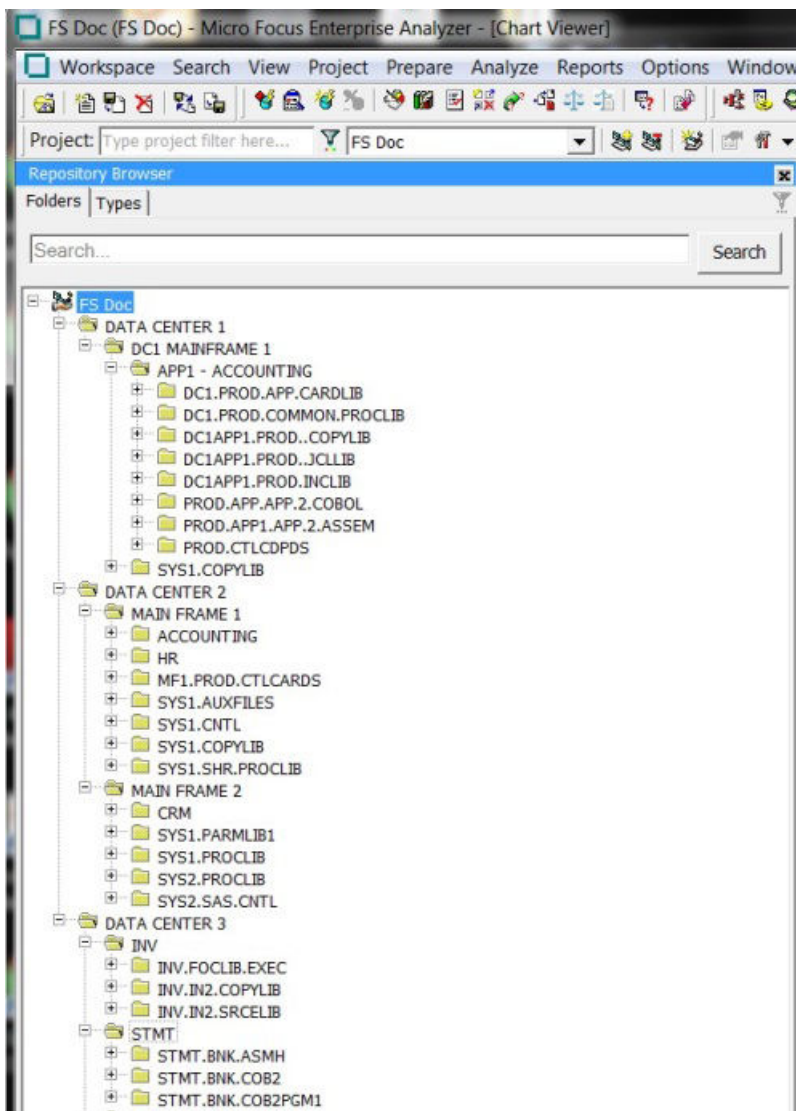

Resolving Include Files

When trying to resolve include files (copybooks, PL/I includes, JCL procedures, etc.), the EA Parser will look at all folders trying to find names that match the included file. If only one match is found, it will use that file. If more than one match is found, EA Parser takes the following steps to resolve which of the matching include files is the one to use:

1. It checks if one of the folders is listed under **Search Path** in the **Homonyms** tab in **Project Options**. The folder can be listed as:
 - an absolute location:



```
C:\Workspaces\FS Doc\Sources\Data Center 1\DC1 Mainframe 1\SYS1.COPYLIB
```
 - or as a relative location under the Sources folder:

```
Data Center 1\DC1 Mainframe 1\SYS1.COPYLIB
```
2. It looks for proximity of the included file to the including file in the source folder structure:
 - First it looks at files that are in the same folder as the "including" source.
 - Then it looks at files in the dependent folders.
 - And then - up the folder hierarchy.

3. Finally folder names will be matched and the "include" folder that has a name with a better match to the source folder name will be selected.

Resolving Program-to-Program Calls

When resolving call relationships between programs, it is possible to reach a point where there is more than one candidate for a called program. In this case EA works the same way as with includes (see *Resolving Include Files*), but since the program objects themselves don't have folders, the folders of the source files that generated them are used.

 **Note:** This same algorithm applies to any relations between non-legacy entities (e.g. PROGRAM reads TABLE, TRANSACTION starts PROGRAM, etc.).

Resolving Control Cards

Control cards can be any members explicitly mentioned in the JCL. When parsing JCLs, EA will look for a file with the member name in the JCL in a folder with a name matching the PDS name from the mainframe.

Resolving JCL Procedures

When looking for JCL procedures, the parser uses the JCLLIB statement, if present. If there is only one copy of the searched procedure, that copy is used. Otherwise, if more than one copy is available, the libraries specified with the JCLLIB statement are used to pick the right one.

Example:

Path to the JCL file: <workspace_path>\Sources\APP1\MYJCL\MYJOB.JCL

```
//MYJOB1    JOB      ...  
//MYLIBS1  JCLLIB  ORDER=CAMPBEL.PROCS.JCL  
//S1       EXEC    PROC=MYPROC1
```

In this case the procedure <workspace_path>\Sources\APP1\CAMPBEL.PROCS.JCL\MYPROC1, if present, will be used.

Queue Processor

There are various ways to set parameters for the Queue Processor.

To launch the Queue Processor

1. Start **EA Administration**.
2. Open **Administer > Launch Queue Processor** or press **F7**.

The Launch Queue Processor window opens.

3. In the **Serve workspace** field type the name of the workspace you want to use or press the ... button to browse for a workspace.
4. Check the **Processing Mode - Conversion, Verification** or both.
5. Choose the number of processors to start . The number depends on your system capabilities.
6. Check **Produce Log File** if you want to produce a log file and then click **OK** to start the verification or **Cancel** to quit.

Check Workspace Queue

Check workspace Queue displays the queued processes that are waiting in queue for the current workspace. To view them:

1. Open **Start Menu > Micro Focus > Enterprise Analyzer > Enterprise Analyzer Administration**.
2. Select **Tools > Check Workspace Queue**. The Select workspace window opens.
3. Select a workspace file (.rwp) and click **Open**. A message with the number of queued records is displayed.

Manage Queue

1. Click **Start > Micro Focus > Enterprise Analyzer > Enterprise Analyzer Administration** to start the Enterprise Analyzer Administration. Manage Queue shows the processes that are waiting to be processed. After the Queue processor has finished the list is automatically cleared.
2. Click **Tools > Manage Queue**. The Manage Queue window opens.

It contains a list of all processes waiting to be processed by the Queue Processor. The available actions are:

- **File > Close** - closes the window.
- **Record > Delete** - if you delete an item from the list it remains unverified and you must re-verify the sources again.
- **Record > Unlock** - unlocks records that are locked due to some verification error.
- **Record > Select All** - selects all records from the queue list.
- **Record > Unselect All** - deselects all records from the queue.
- **Queue > Refresh** - refreshes the queue list.
- **Queue > Show All** - shows all records for the queued processes.
- **Queue > Auto Refresh** - automatically refreshes the list.

Verifying Source Files

Parsing, or *verifying*, an application source file generates the object model for the file. Only a master user can verify source files.

You can verify a single file, a group of files, all the files in a folder, or all the files in a project. It's usually best to verify an entire project. Enterprise Analyzer parses the files in appropriate order, taking account of likely dependencies between file types.



Note: You need not verify copybooks. Copybooks are parsed when the including source file is verified.

If your RPG or AS/400 Cobol application uses copy statements that reference Database Description or Device Description files, or if your MCP Cobol application uses copy statements that reference DMSII DASDL files, you need to generate copybooks for the application before you verify program files.

Workspace and Project Verification options determine verification behavior. The default values for these options are preset based on your configuration and should be appropriate for most installations.



1. In the Repository Browser, select the project, folder, or files you want to verify and choose **Prepare > Verify**.
2. You are prompted to drop repository indexes to improve verification performance. Click **Yes**. You will be prompted to restore the indexes when you analyze the files.

The parser builds an object model for each successfully verified file. For an unsuccessfully verified file, the parser builds an object model for as much of the file as it understands.

How Verification Results Are Indicated

If you have not verified a workspace file, the file is displayed in the Repository pane in **bold** type. Since the system has not generated an object model of the file's contents, only the file itself is displayed.

A verified file shows all the objects in the model generated for the file. Verification results are denoted as follows:

- A blue dot  means that the parser has verified the file successfully.
- A red dot  means that the parser has encountered an error in the file.
- A yellow dot  means that the parser has encountered an error in the file, but that the file has been successfully verified under the relaxed parsing option.



Note: When you edit a file, the modified file and any dependent files are *invalidated*, and need to be verified again. You can learn more about how objects are invalidated and how the system refreshes the repository in *Preparing Projects* in the product documentation set.

Quick Inventory

Quick Inventory is a project related option that automatically registers and verifies referenced files using JCL or PCT files as a starting point. Start by enabling and configuring Quick Inventory, register the JCL or PCT files to be used as the starting points, then verify those files. If you have set all paths correctly, the product will register and verify the external files. Enterprise Analyzer finds its dependencies registers them in the project, and verifies them.

To enable Quick Inventory:

1. In Enterprise Analyzer open **Options > Project Options**.
2. On the **Quick Inventory** tab check **Enable Quick Inventory** and click **Apply**.

Quick Inventory first searches the workspace and if the files are not found there you need to specify the directory where your sources are located. There is a list of pre-defined source types that are supported by Enterprise Analyzer.

To edit, add, delete or select a search path where you want the Quick Inventory to look for sources:

1. In Enterprise Analyzer open **Options > Project Options**.

Click the **Quick Inventory** tab.

2. There is a list with pre-defined search paths suggestions with the names of the object types most commonly used. Select a suggestion, right-click the selected suggestion and then click **Edit**.

- a. Enter the search path to the sources. For example: `COBOL = c:\Sources
\COBOL_Applications_Directory.`



Note: Make sure you enter the correct path. Otherwise EA is not able to find the sources.

- b. Press **Enter**, then check the search path to select it and click **Apply**.
3. If the sources are located in more than one directory (for example if you need to search in more than one COBOL directory outside the workspace), you have to add another entry to the Search Path list. Right-click in the list of suggested directories and then click **Add**. A new item is created in the list. Enter the values you need. For example: `COBOL = C:\Sources\COBOL_Applications_Directory_1.`

Add a new entry for each separate directory you need to search.

4. To delete an entry select it and right-click on it, then click **Delete**.
5. Click **OK** to save the changes, or **Cancel** to undo them and get back to the main Enterprise Analyzer window.

Using the Enterprise Analyzer Main Window

The Enterprise Analyzer main window lets you view and edit projects, set product options, and open EA tools. The window's state is saved across sessions.

Open a pane in the main window by selecting the appropriate choice in the **View** menu. Resize a pane by using the mouse to grab its border with another pane, called a *splitter*, and dragging it to a new location. Close a pane by clicking the  button in the upper righthand corner.

Menus

Enterprise Analyzer menus let you access Enterprise Analyzer tools and other product functionality. Menus are displayed only for the products you have enabled in the Configuration Manager. The table below shows the relationship between products and menus.



Note: The screens shown in the product documentation set display the menu bar with all products installed.

Most Enterprise Analyzer menu choices have equivalent choices in the right-click menu. Menu selections for panes in the main window are available only if the pane has the focus.

| Product | Menu |
|-----------------------|---------|
| Enterprise Analyzer | Analyze |
| Enterprise View | Profile |
| Business Rule Manager | Extract |

Toolbars

You can access a Enterprise Analyzer menu function by clicking its tool bar icon. The tool tip for an icon tells you what it does. Place your cursor over the icon for a moment. The tool tip will display.

A tool bar is displayed only if its corresponding menu is displayed. You can change the position of a tool bar by grabbing the delimiter at the left of the tool bar and dragging it to a new location.

Project Filtering

Filter the projects in the repository browser to see only the one(s) that you want to work with. The Project filter field is on the toolbar. Enter the name of the project you want to see in the Project filter and all other project will be hidden. The filter string is saved when closing and reopening the workspace. To clear the filter, delete the text in the input box and press Enter.

Use wildcards and regular expressions to refine the project filtering.



Note: An asterisk wildcard is assumed at the end of the filter name.

Example

If you have 5 projects named Project 1 through Project 5 and enter Project [1-3] in the project filter, only Project 1, Project 2, and Project 3 will be shown in the browser. If no projects match the filter, the Browser will be empty.

Using the Repository Browser Pane

The Repository Browser pane shows the contents of the repository for the current workspace. It has two tabs:

Folders Displays the contents of the repository in the same folder structure as the one they have in the host environment. This allows for elements with the same name (homonyms) to be loaded and displayed.

Types Displays the contents of the repository by project, object type, and object relationship.

Each of the two tabs consists of the following elements:

Browser Shows the objects in the repository of the current workspace in a tree structure. Depending on the tab you have selected in the Repository Browser pane, the contents are displayed either by type or by folder.

Search Lets you execute various searches in the repository of the current workspace.

In the Browser window, hover your cursor over an object to display a tool tip that describes the object in more detail.

Using the Search Assistant

The Search Assistant is integrated in the Repository pane. It searches all sources in the current workspace. The results are displayed in a tree in the browser window, either by type or by folder, depending on the tab you have selected in the Repository pane - **Folders** or **Types**. The information in the tree is grouped in three levels:

- Project level - shows the projects that contain objects
- Folder level - shows the relative folder structure. If there are more than one folder levels they are grouped and displayed with slashes - `Folder1/Folder2/Folder3(n)`. The number in brackets indicates the number of search result objects in the folder.
- Object level - shows the objects that are the result of the search.

You can customize the search options in **Options > User Preferences > Search Assistant** where you can choose the object types filter. You can also set the maximum time a search can take as well as the maximum number of results that are displayed in **Options > Workspace Options > Search Assistant**.

To use the Search Assistant:

1. Type in a search string in the search box and click . The search returns all workspace objects whose names match the search criteria.
2. Drill down the tree to see the relationship types and available methods for the objects.
3. Double-click an object in the search result tree to see its source code.

 **Note:** To see the source code of a declaration, double-click it or right-click and select **Go To Source**.

4. Right-click the search result objects in the Browser to see the list of available context-sensitive actions for the selected objects.

 **Note:** Multiselect is also available for the items in the search result tree.

To reset a search or change the search criteria in the search field:

1. Click the "x" button in the left corner of the search field.

The search is reset and the last Browser view you used is displayed.

Enterprise Analyzer keeps a history of the searches you have done so when you start typing a search string, it lets you select from a list of search strings you have previously used that begin with the same characters as the ones you have typed.

Using the Browser

The Browser displays the sources in the repository of the current workspace, organized in a tree. Depending on the tab you have selected in the Repository pane, the contents are displayed either by type or by folder. Switch between them to browse the repository in different ways.

- Type view - shows the object model for the workspace, organized in a tree form by project, object type, and object relationship.
- Folder view - shows the sources in the tree in the same folder structure as the one they have in the host environment.



Note: When you work with homonyms, you will see a number in parentheses after the name of the object if there is more than one instance of it.

Selecting Objects

Select an object in the Browser by clicking it with the left mouse button. You can select all, select multiple, or type-ahead select.

Use the **Select** choices in the **Edit** menu to select objects based on their verification status. The choices operate on the entire list in the Search tab and on the objects under the selected workspace, project, or folder in the Browser.

The **Project** drop-down displays the current project. You can navigate quickly to another project in the Browser by clicking the project name in the drop-down.



Note: In the Folders view, you can use multiselect for objects in different folders on the same level.

You cannot use multiselect for child and parent nodes.

You cannot use multiselect across projects.

Selecting All

To select all the objects in the tree or all the objects in the selected node, choose **Edit > Select All**. To deselect the objects, choose **Edit > Unselect All**.

Selecting Multiple



To select a range of objects, hold down the Shift key, click the first object in the range, then click the last object in the range. To select objects that are not in a range, hold down the Control key, then click each object you want to select.

Using the Type-Ahead Select Functions

Use the *simple type-ahead select function* to select displayed objects as you type. To use the simple function, make sure the Browser tab is current, then type the characters you want to match.







Note: You cannot use the simple type-ahead select function in the Search tab.

Use the *advanced type ahead select function* to select objects in the Browser or Search tab whether or not they are currently displayed. To use the advanced function, click an object that has the same type as the object you want to select, then click the  button next to the  button at the bottom of the Repository pane (or if the filter subtree function is enabled, next to the  button). From the drop-down menu, choose:

- **Select** to match text explicitly.

- **Wildcard Select** to match text using wildcard patterns.



Enter the text you want to match in the field next to the  button. The tool selects matched objects as you type, as long as they are in the same subtree. Click the  button to repeat the select with the same criterion.

To select multiple objects, enter the text you want to match in the field next to the  button, then click the adjacent  button. From the drop-down menu, choose:

- **Select All** to select multiple objects that match text explicitly.
- **Wildcard Select All** to select multiple objects that match text using wildcard patterns.

The tool selects matched objects as long as they are in the same subtree. Click the  button to repeat the select with the same criterion.

Expanding Subtrees



Click the  symbol next to an item to expand its subtree one level. Click the  symbol to collapse the subtree one level.

In the Repository Browser, select an item and choose **Expand Subtree** in the right-click menu to expand all its subtree levels in a single step. Select an item and choose **Save Subtree** in the right-click menu to export the label text for expanded subtree levels to a text file.



Note: For subtrees with a great many objects, you can improve browser display performance by filtering the subtree and/or by lowering the fetch buffer size in the General tab of the Workspace Options window.

Filtering Subtrees

For a subtree with a great many objects, you can improve browser display performance by showing only objects of interest in the subtree. To filter out objects from a subtree, select the subtree, then enter the text you want to match in the field next to the  button at the bottom of the Repository pane (or if the type-ahead select function is enabled, next to the  button). Click the adjacent  button and choose **Filter** from the drop-down menu.

The tool filters out unmatched objects from the subtree, and places a  symbol next to the subtree in the browser display. The filter and filter text are persistent for the subtree across sessions. To remove the filter and its text, enter an empty string in the text field and choose **Filter** again.

Refreshing the Browser

In a multiuser environment, you need to *refresh the browser* after another user adds, deletes, or modifies a workspace file. Choose **View > Refresh Browser** to refresh the browser.

Viewing the Entire Workspace

By default, the Browser tab displays repository trees for projects only. These trees show only objects you can act on in the browser. To view all the objects in the workspace, choose **View > Entire Workspace**, or select (none) in the **Project** drop-down. Choose **View > Entire Workspace** again, or select a project in the **Project** drop-down, to display the project only.

Using the Legacy Search Tab

The Legacy Search tab displays a sorted list of workspace objects returned by a search filter. Select objects in the Legacy Search tab the same way you do in the Browser tab.

To execute an existing search filter, choose **Edit > Search Criteria**. In the **Filter Name** drop-down, choose the filter for the search, then click **Find**. The results are returned in the Search tab.

 **Note:** By default, the results list shows two attributes of an object: its name and file type. Use the General tab of the Workspace Options window to display additional attributes.

Creating a Search Filter

You can use predefined filters to search for objects in the Repository pane or create your own filters. You cannot modify a predefined filter.

1. Choose **Edit > New Criteria**. The Search dialog opens.

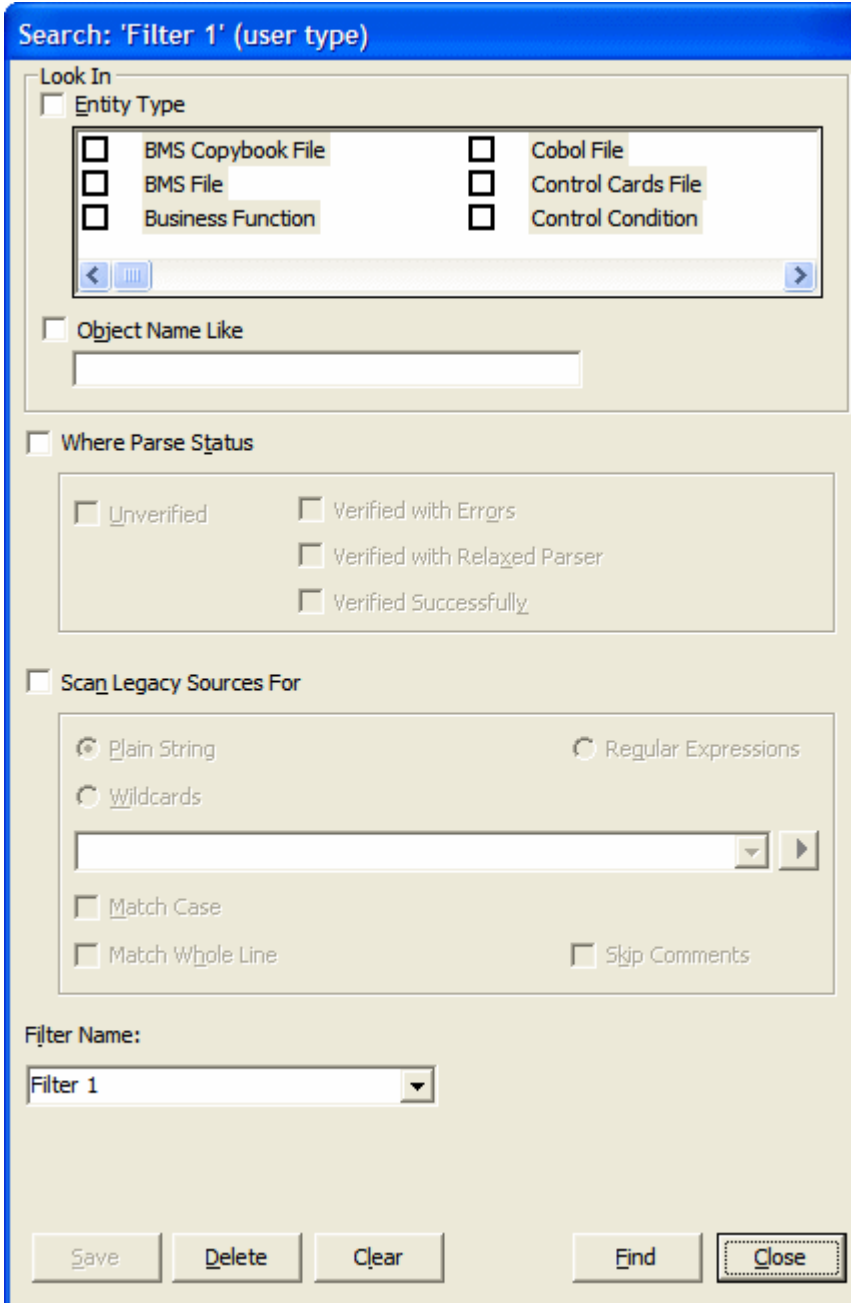

Search: 'Filter 1' (user type)

Look In

Entity Type

| | |
|--|---|
| <input type="checkbox"/> BMS Copybook File | <input type="checkbox"/> Cobol File |
| <input type="checkbox"/> BMS File | <input type="checkbox"/> Control Cards File |
| <input type="checkbox"/> Business Function | <input type="checkbox"/> Control Condition |

Object Name Like

Where Parse Status

| | |
|---|--|
| <input type="checkbox"/> Unverified | <input type="checkbox"/> Verified with Errors |
| <input type="checkbox"/> Verified with Relaxed Parser | <input type="checkbox"/> Verified Successfully |

Scan Legacy Sources For

Plain String Regular Expressions

Wildcards

Match Case

Match Whole Line Skip Comments

Filter Name:

Filter 1

Save Delete Clear Find Close

2. Choose any allowed combination of the following:

- To filter on object type, select the **Entity Type** check box and choose the entity type in the pane below.
 - To filter on object name, select the **Object Name Like** check box and enter a matching pattern for the name in the accompanying field. You can use wildcard patterns allowed in LIKE statements by Visual Basic for Applications (VBA).
 - To filter on verification status, select the **Where Parse Status** check box and choose the status in the group box below.
 - To filter on a text string in the source, select the **Scan Legacy Sources For** check box, then specify the search criterion. Select the check boxes below the drop-down if you want the search to match case, skip comments, and/or match whole lines.
3. In the **Filter Name** drop-down, enter the name of the search filter and click **Save**.
 4. To edit a search filter, select it in the **Filter Name** drop-down and follow the instructions for creating a filter. To delete a search filter, select it in the **Filter Name** drop-down and click **Delete**. To clear a search filter, select it in the **Filter Name** drop-down and click **Clear**.



Note: To execute a search directly from the Search dialog, select the search filter in the **Filter Name** drop-down and click **Find**. The results are returned in the Search tab.

Specifying a Search Criterion

Follow these instructions to specify a search criterion in find and replace operations and in search filters.

1. Click the radio button for the type of pattern matching you want to use.
2. In the combo box:
 - Select the pattern for the text you want to match. The drop-down lists matching patterns from previous searches.
 - Enter a new matching pattern by typing in the combo box. You can enter plain character strings, Posix regular expressions, or wildcard patterns allowed in LIKE statements by Visual Basic for Applications (VBA). For regular expressions and wildcard patterns, click the  button next to the drop-down to display a pop-up menu of elements you can insert in the pattern. Click an element to insert it. The matching pattern is saved when you execute the search.

Using Wildcard Patterns in Searches

In most searches you perform in the EA tools, you can use wildcard patterns allowed in LIKE statements by Visual Basic for Applications (VBA). The table below shows the wildcard characters and what they match.

| Character | Matches |
|-------------|---------------------------------------|
| ? | Any single character. |
| * | Zero or more characters. |
| # | Any single digit (0–9). |
| [charlist] | Any single character in charlist. |
| [!charlist] | Any single character not in charlist. |

To match the special characters left bracket ([), question mark (?), number sign (#), and asterisk (*), enclose them in brackets. The right bracket (]) cannot be used within a group to match itself, but it can be used outside a group as an individual character.

Specify a range of characters in a charlist by using a hyphen (–) to separate the upper and lower bounds of the range. [A–Z], for example, results in a match if the corresponding character position in a string contains any uppercase letters in the range A–Z. You can specify multiple ranges in brackets without delimiters.

Finding and Replacing Text in Source Files

You can find and replace text in source files from the Browser or Search tab of the Repository pane. Use the Editor to replace text in a selection of source code.

1. In the Browser or Search tab, select the source files or the node that contains the source files you want to search and choose:
 - **Edit > Find** if you simply want to search.
 - **Edit > Replace** if you want to search and replace.
2. The Find and Replace dialog opens. Click the tab for the operation you want to perform.



Note: The find functionality in the Find tab is bidirectional. You can search up or down, and specify that the search wrap. The find functionality in the Replace tab is unidirectional. Otherwise, the find functionality is identical in each tab. The remaining steps assume that you want to both search and replace.

3. In the **Find What** combo box, specify the search criterion. Select the check boxes below the drop-down if you want the search to match case and/or match whole words.
4. In the **Replace With** combo box, select the replacement text. The drop-down lists text strings from previous replace operations. Enter new replacement text by typing in the combo box. If you used regular expressions for the find, click the  button next to the drop-down to display a list of elements you can insert in the replacement text field.
5. Click **Find Next**. When the search finds a match, click **Replace**. You are prompted to confirm the replacement. Click **Yes**. Click **Find Next** again to find the next match, or click **Replace All** to replace all matching text.

Using the Editor and Viewer

The Editor lets you view and edit the source code for a file. The Viewer lets you view renderings of logical objects like screens and transformation target models. Double-click a file in the Repository pane to view it in the Editor or Viewer. Choose **File > Recent Sources** to open a file from a list of recently opened files.

Editing Source

Edit file source as you would text in a word processor (cut-and-paste, drag-and-drop, undo, and so forth). Click **File > Save** to save your changes. Edits are saved in the copy of the file maintained in the `\Workspace\Source` subfolder.



Note: When you edit a file, the modified file and any dependent files are invalidated, and need to be verified again. Only a master user can edit and verify source in a multiuser environment.

Finding and Replacing Source in a Selection

To find and replace source in a selection of text, select the text, then follow the instructions for the source file find and replace function.

Viewing a List of Errors

For a source files with errors or warnings, right-click in the Editor and choose:

- **Errors > View Errors** from the popup menu to list the errors and warnings in a separate pane below the Editor. Choose **Edit > Errors > View Errors** again to hide the pane.
- **Errors > Next Error** from the popup menu to navigate to the offending source code for the next error in the list.
- **Errors > Previous Error** to navigate to the offending source code for the previous error in the list.
- **Errors > Severity Filter** from the popup menu to filter the list by severity.



Note: You can set a severity filter for all your workspaces in the Editor User Preferences.

- **Errors > Copy Errors** in the pop-up menu to copy the list of errors and warnings to the clipboard.

To hide the Editor and show only the list of errors and warnings for the selected file, right-click in the Repository pane and choose **Show Errors** in the pop-up menu. Double-click the source file in the Repository pane to show the Editor again.

Extracting and Expanding Copybooks (Cobol, MFS Only)

To extract source code as a copybook, select the code you want to extract, then choose **Edit > Extract Copybook**. A dialog box opens, where you can enter the name of the new copybook. Click **OK**. The new copybook is added to the repository and the extracted code is replaced by a COPY statement referencing the new copybook.

To expand COPY statements, choose **Edit > Expand Copy Statements**. The added lines of code are highlighted and a comment line is inserted to identify the source copybook.

Commenting Out Source

To comment out a block of source, select the block and choose **Edit > Comment Block**. To uncomment the block, select it and choose **Edit > Uncomment Block**.

Printing Source

To print the source for a file, choose **File > Print**.

Setting Editor User Preferences

Use the Editor tab of the User Preferences window to specify the display characteristics of the Editor.

1. Choose **Tools > User Preferences**. The User Preferences window opens. Click the Editor tab.
2. In the **Font** drop-down, select the display font for source code.
3. Select the **Colorize Text** check box if you want to use a color scheme to identify source elements, then specify the color of each source element.
4. In the Show Errors pane, select the check box for each type of error you want to show in the error list.

Specifying the Color of Items

You use a standard Windows color control to specify a color scheme for source elements and other items. Use the Palette tab to select a color from the Windows palette. Use the System tab to match the color of a standard Windows element. Depending on the element, you can specify the foreground color, background color, and/or font color.

Using the Object Information Pane

The Object Information pane displays comments you have entered for an object. Select an object in the Repository pane and choose **View > Object Information** to show the Object Information pane.

Enter comments for an object by selecting the object in the Repository pane and choosing **Properties** in the right-click menu. In the Description tab, enter your comment in the text area and click **OK**.



Note: You cannot use this method to enter comments for a workspace (that is, when an entire workspace is displayed in the Repository Browser). Use the General tab of the Workspace Options window to enter comments for a workspace.

Viewing Object Properties

The *properties* of an object describe its characteristics: its language, complexity metrics, relationships, and the like. Select an object in the Repository pane and choose **View > Properties** to display a set of tabs with object properties. The table below describes the tabs in the Properties window.



Note: In other EA tools, use the right-click menu or the **View** menu to display the properties of the selected object.

| Tab | Description |
|---------------|--|
| Description | Displays comments you have entered for the object. |
| General | Displays the name and other general information for the object. |
| Internal | Displays verification option settings and other internal information for the object. |
| System | Displays system information for the object. |
| Statistic | Displays the complexity metrics for the object and their values. |
| Relationships | Displays the relationships of the object. Only the first relationship level is shown but if you want to explore a particular branch you can do it by double-clicking the object. Select Restricted to the current project to restrict relationships to those in the current project. Select Workspace wide to show all the relationships of the object in the workspace. |
| Object Tags | Displays the tags assigned to the object. |

Viewing Inventory Reports

Inventory Reports give high-level statistics for source file types in the current workspace: number of files of each type, whether verified, number of lines of source code (verified files only), and the like. To generate an Inventory Report, choose **Prepare > Inventory Report**. The table below describes the columns in the Inventory Report.

| Column | Description |
|--------------|---|
| Type | The source file type. |
| Source Lines | The number of lines of source code in verified files of the specified type. |
| Quantity | The number of source files of the specified type. |
| Unverified | The number of source files of the specified type for which verification was not attempted.  Note: Copybooks do not need to be verified. Copybooks are parsed when the including source file is verified. |
| Verified | The number of successfully verified source files of the specified type. |
| Erroneous | The number of unsuccessfully verified source files of the specified type. |
| Relaxed | The number of source files of the specified type that were verified despite errors, under the relaxed parsing option. |
| Missing | The number of missing support files (copybooks, JCL procedures, and the like). |

Viewing Key Object Relationships with Query Repository

The Query Repository feature lets you home in on key relationships of an object: all the programs that call another program, or all the programs that update a data store, for example. From the results, you can launch further queries without having to return to the Repository Browser. You can create printable relationship reports and export them to a variety of standard formats.

1. In the Repository pane, select the workspace, project, folder, files, or objects you want to view relationships for and choose **Query Repository > <Relationship>** in the right-click menu. The Query Repository results pane opens over the Editor/Viewer.
2. To launch a query from the results, select one or more objects in the right-hand column and choose **Query Repository > <Relationship>** in the right-click menu.

Using the Activity Log

The Activity Log is a chronological record of your activities in the current session. Choose **View > Activity Log** to show the Activity Log pane.

Viewing Errors

If the parser generated errors or warnings for a file, double-click the Activity Log entry for the file or select the entry and choose **Expand** in the right-click menu to show a list of the errors and/or warnings. Double-click a message to navigate to the offending source in the Editor. Choose **Collapse** in the right-click menu to collapse the list.

Viewing History

To view Activity Log entries across sessions, choose **History** in the right-click menu. Click a date to view the session log. To clear the session log, right-click in the log and choose **Clear Log** in the pop-up menu. To clear a log entry, select the entry and choose **Delete** in the right-click menu.

Copying Records

To copy Activity Log records to the clipboard, select the records and choose **Copy** in the right-click menu.

Generating Reports

To generate a report from the Activity Log, right-click in the log and choose **Report** in the pop-up menu.

Clearing the Log

To clear the Activity Log, right-click in the log and choose **Clear Log** in the pop-up menu. To clear a log entry, select the entry and choose **Delete** in the right-click menu.

Hiding a Column

To hide a column in the Activity Log, right-click in the log and deselect the column name in the **Columns** choice in the pop-up menu. Select the column name to show the column again.

Creating a To Do List

A *to do list* is a record of tasks you need to perform before completing your project. You can create a to do list for a workspace, project, folder, source file, or extracted object.

1. In the Repository Browser, select a workspace, project, folder, source file, or generated object and choose **View > ToDo List**. The ToDo List window opens.
2. If you selected:
 - A workspace, project, or folder, choose **Edit > Add** to enter a task for the item and all the items it contains. Otherwise, choose **Add for Item** to enter a task for the workspace, project, or folder only.
 - A source file or generated object, choose **Edit > Add** to enter a task for the item.
3. The New Properties dialog opens. In the **Subject** field, enter the name of the task. In the **Content** field, enter a description of the task. Click **OK**. The task is listed in the ToDo List window.

Viewing a To Do List

To view the to do list for an item, select the item in the Repository Browser and choose **View > ToDo List**. Use the options in the ToDo List window **Edit** menu to mark a task as done, delete a task, or view its properties. You can generate a report from a to do list by choosing **File > Report**.

Using Tool Windows

When you open an Enterprise Analyzer tool, the window for the tool appears above the product main window. Simply move the tool window if you want to work in the main window again. A tool window's state is saved across sessions. Close a tool window by clicking the **×** button in the upper righthand corner.

Tool windows are *modeless*: in principle, you can open as many tool windows as you want. In practice, Enterprise Analyzer will prompt you to close an “unprotected” tool window if the activity you want to perform could result in a repository change. An unprotected tool window cannot be updated to reflect a concurrent repository change.

In tool windows with lists, you can select all, select multiple, size columns, and sort by column.

Resizing Panes

Resize a pane in a tool window by using the mouse to grab its border with another pane, called a *splitter*, and dragging the border to a new location. To control how panes are resized when you resize the window, select the splitter and choose one of the following in the right-click menu:

- For a vertical splitter, **Keep First** preserves the size of the panes to the left of the splitter. For a horizontal splitter, **Keep First** preserves the size of the panes above the splitter.
- For a vertical splitter, **Keep Second** preserves the size of the panes to the right of the splitter. For a horizontal splitter, **Keep Second** preserves the size of the panes below the splitter.
- **Keep Proportion** preserves the length and width ratio of the panes on either side of the splitter.

Moving Panes

Move a pane in the window by grabbing its title bar to show the “virtual rectangle” for the pane. The virtual rectangle is a dotted color frame that you can drag to the position in the window at which you want the pane to appear. When you are satisfied with the new position, release the mouse button. The other panes in the window are adjusted as necessary.



Note: You may have to drag the virtual rectangle beyond the edge of the tool window to achieve the effect you want.

To swap the positions of the panes on either side of a splitter, select the splitter and choose **Swap** in the right-click menu. To change the color of the splitter when it is selected (and of its virtual rectangle), select the splitter and choose **Color** in the right-click menu. Use the standard Windows color control to specify the color.

Setting Options

Enterprise Analyzer options control the look and feel of the product tools and how they perform their tasks. The **Tools** menu gives you access to three sets of options:

- **Workspace Options** control the appearance and behavior of EA tools for the current workspace.
- **Project Options** control the appearance and behavior of EA tools for the current project.
- **User Preferences** control the appearance and behavior of the Editor, Interactive Analysis, and Change Analyzer across workspaces, and miscellaneous other tasks.

Each tool has an **Options** choice in the **View** menu that lets you set the options for that tool.



Note: Many options are preset based on your choices in the Enterprise Analyzer Configuration Manager. For more information, see the installation guide for your product.

Tool options are described in detail in the relevant sections of the documentation set. This section shows you how to manage option sets and how to set general EA and environment options

Managing Option Sets

An *option set* is a particular configuration of settings for one of the option groupings. In a given Project Options set, for example, you might choose to show GO TO statements in the Interactive Analysis Callie tool, while in the other Project Options sets you would not.

Option sets let you switch back and forth between configurations in the same session, without having to change settings manually. You can also use them to ensure uniform results across your team by sharing customized settings with team members.

Understanding the Options Manager Window

Use the Options Manager to define custom options sets. Choose **Tools > Options Manager** to open the Options Manager window.

The figure below shows the Options Manager window at startup, with the tab for the Workspace Options grouping selected. For each grouping, there is an initial read-only *default option set*, denoted by a  symbol, that reflects your current EA configuration. The *active* option set is displayed in **bold** type in the Options Manager tab for the grouping. You make an option set active by *assigning* it. Assignments persist across Enterprise Analyzer sessions.

The user who defines a custom option set is referred to as its *owner*. Only the owner can *share* a custom option set with other users, as indicated by a  symbol. A shared option set cannot be deleted or unshared if it is being used. The **Used By** drop-down at the bottom of the owner's Options Manager window lists the names of option set users. The owner's name appears in the Owner column in the Options Manager window displayed to other users (but not in the owner's Options Manager window).

The initial default option set is always shared with other users. An owner can designate another option set as the default, provided the option set is shared. The new default option set will automatically be assigned to every user who has not explicitly defined a custom option set. A default option set cannot be modified or deleted.

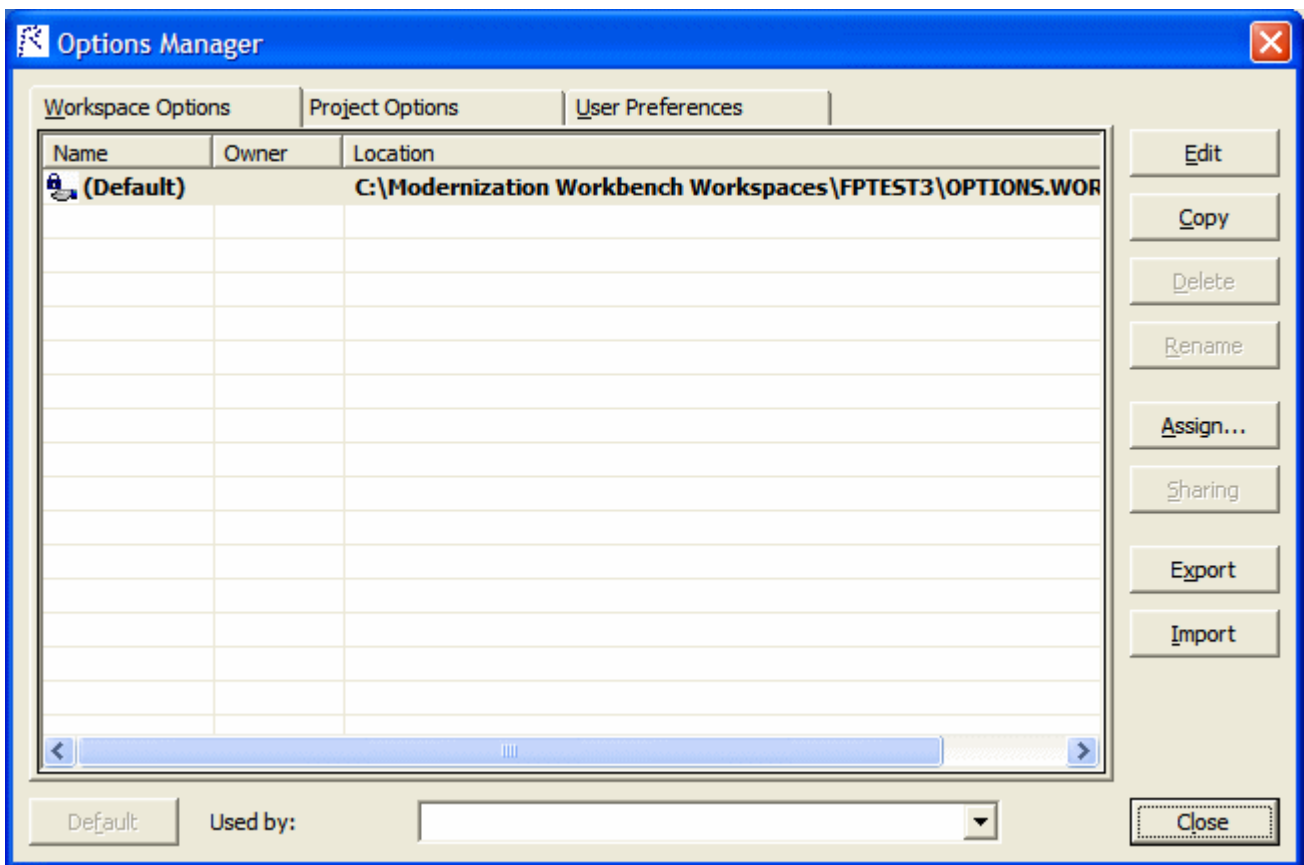

Creating an Option Set

If there is only a “(Default)” option set for the grouping, select it and click **Edit**. Otherwise, select any option set and click **Edit**. Options Manager displays the available tabs for the selected options grouping.

Modify the options displayed on each tab as necessary and click **Apply**. When you are satisfied with your choices, click **OK**. The new option set is displayed in the Options Manager window with the name of the grouping.



Note: If a default option set already uses one of the grouping names, Options Manager prepends “Copy of” to the name.

Renaming an Option Set

To rename an option set, select it and click **Rename**. The system displays the current name in an edit box. Enter the new name in the edit box and click outside the box.

Editing an Option Set

To edit an option set, select it and click **Edit**, then follow the instructions for creating an option set. You cannot edit a default option set.

Copying an Option Set

To copy an option set, select it and click **Copy**. Options Manager prepends “Copy of” to the name of the copied option set.

Deleting an Option Set

To delete an option set, select it and click **Delete**. You cannot delete a default option set, or a shared option set that has been assigned by another user.

Sharing an Option Set

To share an option set, select it and click **Sharing**. The button is a toggle. Select it again to revoke sharing. You cannot revoke sharing for an option set that has been assigned by another user.

Making an Option Set the Default

To make a custom option set the default, share it first, then select it and click **Default**.

 **Note:** In the Project Options tab, a dialog opens that prompts you to select or create a new project. Select the project and click **OK**.

The new default option set is automatically assigned to every user who has not explicitly defined a custom option set. A default option set cannot be modified or deleted.

Assigning an Option Set

To make an option set active, select it and click **Assign**.

 **Note:** In the Project Options tab, a dialog opens that prompts you to select or create a new project. Select the project and click **OK**.

Importing and Exporting Option Sets

To import an option set, click **Import**. A Load dialog opens, where you can specify the option set you want to import.

To export an option set, select it and click **Export**. A Save dialog opens, where you can specify the name and location of the option set.

Setting General Options

Use the General tab of the Workspace Options window to specify the description of the workspace displayed in the Object Information pane, the attributes displayed in the Repository pane Search tab, and the browser fetch buffer size.

1. Choose **Options > Workspace Options**. The Workspace Options window opens. Click the General tab.
2. In the **Workspace description** field, enter a description of your workspace. This description is shown in the Object Information pane.
3. In Repository Browser (Search), check the boxes for the object attributes that should be displayed in the Search tab of the Repository pane. Click **Select All** to check all the attributes.

 **Note:** Only attributes in the repository model for an object are displayed. That is, if you choose Cyclomatic Complexity, and only JCL files appear in the Search tab results list, the attribute will not be displayed in the list, because Cyclomatic Complexity is not an attribute of a JCL file.

4. In the **Browser Fetch Buffer Size** field, enter the size of the buffer Enterprise Analyzer uses to populate the repository tree. When you expand a node in the Repository Browser, Enterprise Analyzer populates the display from a buffer that contains the objects last fetched from the repository. For very large repositories, you may want to lower the buffer size so that you can work with objects in the Repository Browser while the product performs subsequent fetches.

Setting Environment User Preferences

Use the Environment tab of the User Preferences window to specify whether you want to be prompted to verify source files after registering them and the scope of relationships shown in the Object Properties window.

1. Choose **Tools > User Preferences**. The User Preferences window opens. Click the Environment tab.
2. In After new files are registered, choose:
 - **Verify registered files** if you want Enterprise Analyzer to verify files after they have been registered.
 - **Ask user about verification** if you want to be prompted to verify files after they have been registered. Available whether or not **Verify registered files** is selected.
3. In Show relationships in the object properties view window, choose whether you want to restrict the relationships displayed in the Relationships tab of the Object Properties window:
 - **Restricted to the current project** if you want to restrict the relationships of the object to those in the current project.
 - **Workspace wide** if you want to display all the relationships of the object in the current workspace.
4. For Java support, specify the path of the folder for the Java Runtime Environment (JRE) on your machine in the **Path to JRE Folder** field. If you do not enter a path, the current version specified in the Windows registry is used. You must use JRE version 1.5 or later.



Note: If your application was compiled with a previous version of the JRE, specify the path of the Java SE runtime library (rt.jar) used to compile the application in the **Enter classpath to JAR Files and/or path to external Java file root directories** field in Workspace Options > Verification > Settings.

Setting Archivers User Preferences

The EA registration process extracts compressed source files using the command line syntax for archiver versions most widely in use. Use the Archivers tab of the User Preferences window to specify the command line syntax for newer archiver versions.

1. Choose **Tools > User Preferences**. The User Preferences window opens. Click the Archivers tab.
2. In the **Command Line for Archiver** drop-down, choose the archiver whose command line syntax you want to specify.
3. In the **Unpack All** field, enter the command line syntax for the unpack all operation.
4. In the **Extract File** field, enter the command line syntax for the extract file operation.

Setting Export Options

Use the Export Options tab of the Project Options window to specify where Enterprise Analyzer stores generated files. The default location is the `\<Workspace Home>\Output` folder.

1. Choose **Options > Project Options**. The Project Options window opens. Click the Export Options tab.
2. In the **Target directory** field, enter the folder you want Enterprise Analyzer to store generated files in.
3. Deselect the **Move Files** check box if you want to copy generated files to both the default and the specified directories.

Adding a Selectable Item

Many options windows allow you to add an item to a list of available items. In the Extensions tab of the Workspace Registration options, for example, you can add an extension to the list of recognized extensions.

Add an item by right-clicking in the selection pane and choosing **Add** in the pop-up menu. The EA displays an empty text field next to a selected check box. Enter the name of the item in the text field and click outside the field.



Note: If you are entering a file extension, make sure to enter the dot (.).

Edit an item by selecting it and choosing **Edit** in the right-click menu. Delete an extension by selecting it and choosing **Delete** in the right-click menu.

Working with Reports and Diagrams

When you generate a diagram or report in the Enterprise Analyzer, you typically have the option of saving it to a file or printing it. You can save to a wide variety of standard formats.



Note: Word must be installed to save reports to RTF and Word. Excel must be installed to save reports to Excel, CSV, and TXT. Visio 2002 must be installed to save a diagram to Visio. Visio 2002 is not required to save to Visio XML.

Click **Page Setup** in a report window to set up the page for a printed report. Click **Print** to print the report. The Print dialog opens, where you can set options for the print job. Click **OK**.

Click **Save** in a report window to export a report. A Save As dialog opens, where you can specify the name, location, and file type of the report.

Using the Guide for a Tool

Many Enterprise Analyzer tools have guides that you can use to get started quickly in the tool. The guides are help-like systems with hyperlinks that you can use to access functions otherwise available only in menus and other program controls.

To open the guide for a tool, choose **View > Guide**. Use the table of contents in the **Page** drop-down to navigate quickly to a topic.

Purge Activity Log

Activity Log grows in size. To remove unwanted information, use Purge Activity Log to permanently delete contents from the database.

1. Open Micro Focus Enterprise Analyzer Administration.
2. Click **Tools > Purge Activity Log**. The **Purge Activity Log** window opens.
3. Select a date from which to delete Activity Log data.
 - Click **Delete** to proceed with log deletion. This will actually delete items from the Activity Log history table in the database.
 - Click **Close** to exit without any change.